

MECOLINE



The simple EDM clamping solution

MECOLINE

Open the case and off you go!

With MECOLINE you are laying the foundations for a simple workpiece clamping system for your EDM machine. Inside the practical carrying case, you will find all the screws, collets and hex socket keys that you need to set up your workpiece rapidly and efficiently. MECOLINE - your helping hand!

Set
MECOLINE Vice 150
Article no: S 400000

- 1 vice, 150 mm
- 1 set of fixing accessories
- 1 set of hex keys
- 1 carrying case



Assembly couldn't be easier ...

Simply screw in the M6 or M8 screws at a distance of 80 to 120 mm apart, adjust and that's it!

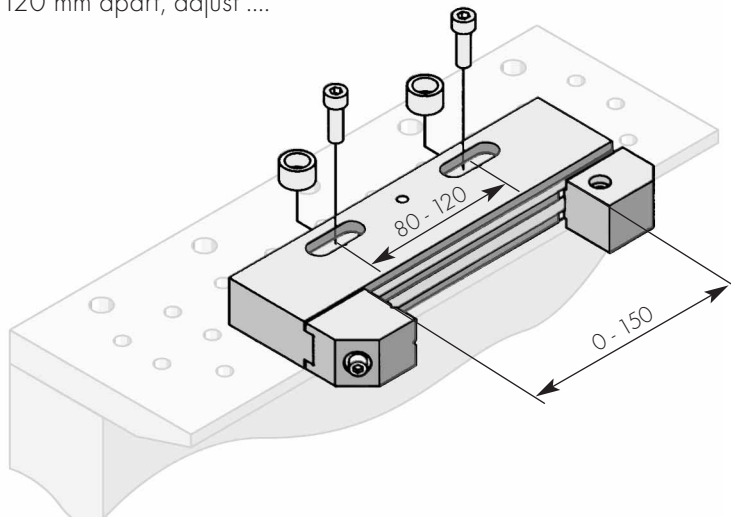





MECOLINE Vice 150

Simple and direct

For the safe and secure clamping of workpieces up to 10 kg in weight.



... it really couldn't be simpler!

-  machine-independent
-  simple to assemble on all EDM machines
-  for the collision-free clamping of workpieces up to 10 kg in weight
-  clamps workpieces from 1 mm to 150 mm in size
-  the universal solution whatever the budget





ICS Standard

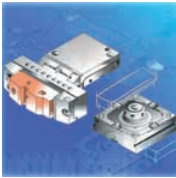

Unimatic™



GPS Mini



GPS 70/120



GPS 240

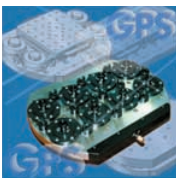

GPS 240 Twin



Shopboy

INTECH EDM®

U.S. Headquarters (Chicago)

2001 W. Parkes Drive
Broadview, IL 60155-3952
Tel: 708-681-6110 or 800-323-0295
Fax: 708-681-0447 or 800-325-7584

Western Branch (Los Angeles)

22138 S. Vermont Ave. • Unit G
Torrance, CA 90502
Tel: 310-328-1060 or 800-328-1020
Fax: 310-328-0215

Canadian Branch (Toronto)

6975-D Pacific Circle
Mississauga, Ontario L5T 2H3
Tel: 905-565-6942 • 800-243-5853
Fax: 905-565-6945

Internet

Web Site: www.intech-edm.com
Bulletin Board: www.EDMtalk.com
E-mail: info@intech-edm.com